

TECNORD

SERVOCOMANDI E REGOLAZIONE



CONTROL SOLUTIONS for
REACH MOWERS



TECNORD

Via Malavolti, 36 - 41122 Modena - Italy - Tel. +39 (059) 254895 - Fax +39 (059) 253512
tecnord@tecnord.com - www.tecnord.com

INDEX

GARDEN RANGE

SOFT-START PROPORTIONAL SYSTEMpage 4

AGRICULTURE RANGE

METER-IN PROPORTIONAL SYSTEMpage 6

PROFESSIONAL RANGE

MULTI-FUNCTIONAL PROPORTIONAL SYSTEMpage 8

PRODUCT HIGHLIGHTS

JOYSTICKS AND ARMRESTSpage 10

MACHINE MANAGEMENT SYSTEMpage 11

CARTRIDGE VALVESpage 12

TDV DIRECTIONAL PROPORTIONAL VALVEpage 13



MAIN CONTROL VALVE

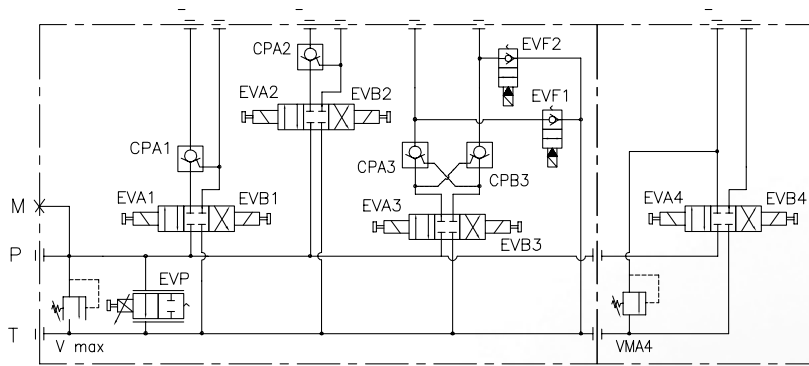

MAIN CONTROL VALVE

FUNCTIONS

- 1ST BOOM
- 2ND BOOM
- BOOM ROTATION
- HEAD ROTATION
- HEAD FLOAT

The soft start control permits the gradual engagement of each function. While the proportional flow control valve (EVP) is still bypassing flow to tank, the selected on/off function is activated. Then the PWM signal progressively

closes the EVP, generating smooth flow and pressure build-up to the energized function. The function release works in the opposite way, smoothly bypassing oil to tank and then de-energizing the on/off valve.

FLAIL CONTROL VALVE

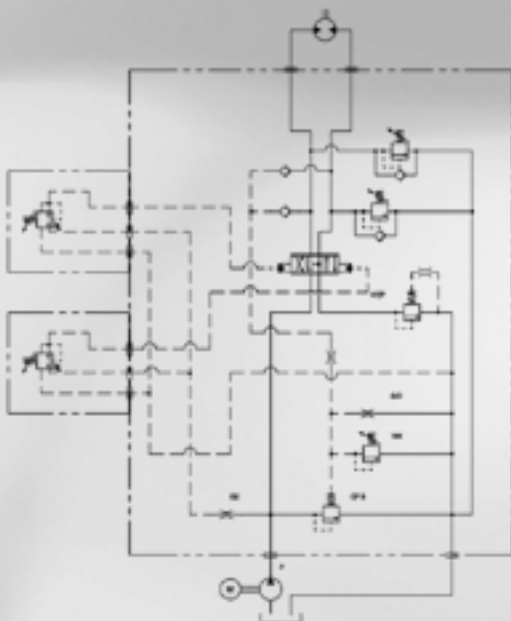

Combining the special spool design and the LS control, this directional proportional valve provides enhanced performances respect the traditional systems:

- Smooth and fast acceleration without pressure spikes, even if engaged at max rpm.
- Smooth and fast deceleration (50% time reduction).
- Energy saving by the LS pressure compensator.

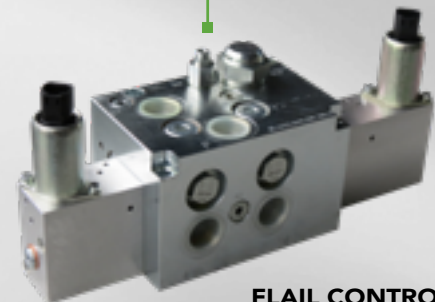
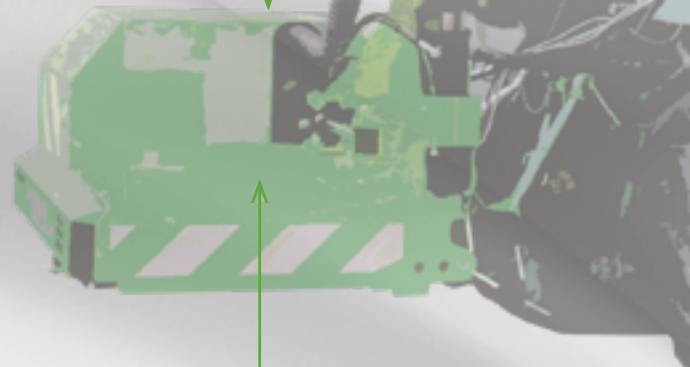

FLAIL CONTROL VALVE

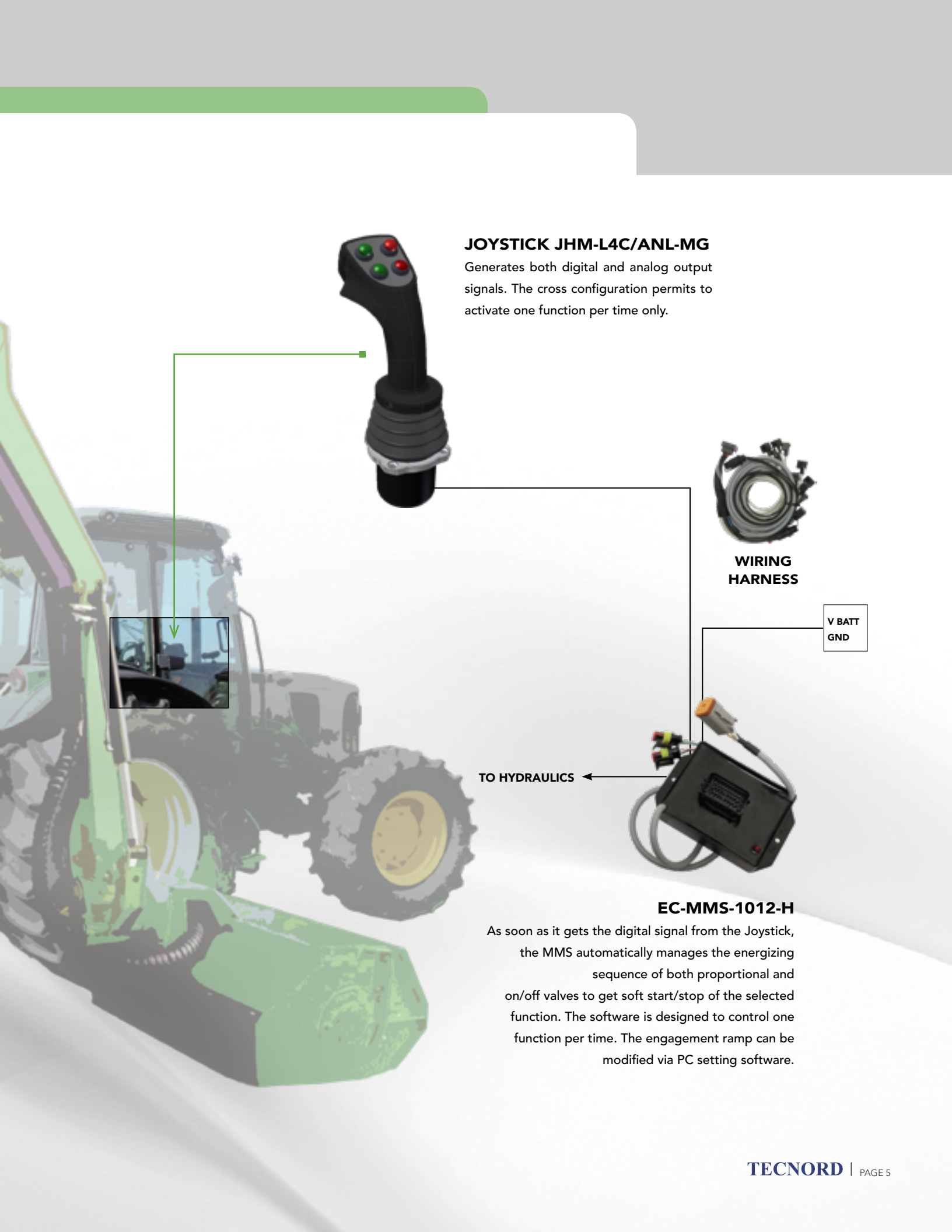

JOYSTICK JHM-L4C/ANL-MG

Generates both digital and analog output signals. The cross configuration permits to activate one function per time only.



WIRING HARNESS

V BATT
GND

TO HYDRAULICS ←



EC-MMS-1012-H

As soon as it gets the digital signal from the Joystick, the MMS automatically manages the energizing sequence of both proportional and on/off valves to get soft start/stop of the selected function. The software is designed to control one function per time. The engagement ramp can be modified via PC setting software.

MAIN CONTROL VALVE

SINGLE/DOUBLE PROPORTIONAL METER-IN

According to the angular position of the joystick lever, the pressure compensated proportional valve EE-P2G regulates the flow to the function selected by the joystick direction. Based on the HIC configuration (single or double

proportional) one or two functions can be controlled contemporaneously. The EVDE is actuated according to the inclination of the first boom.

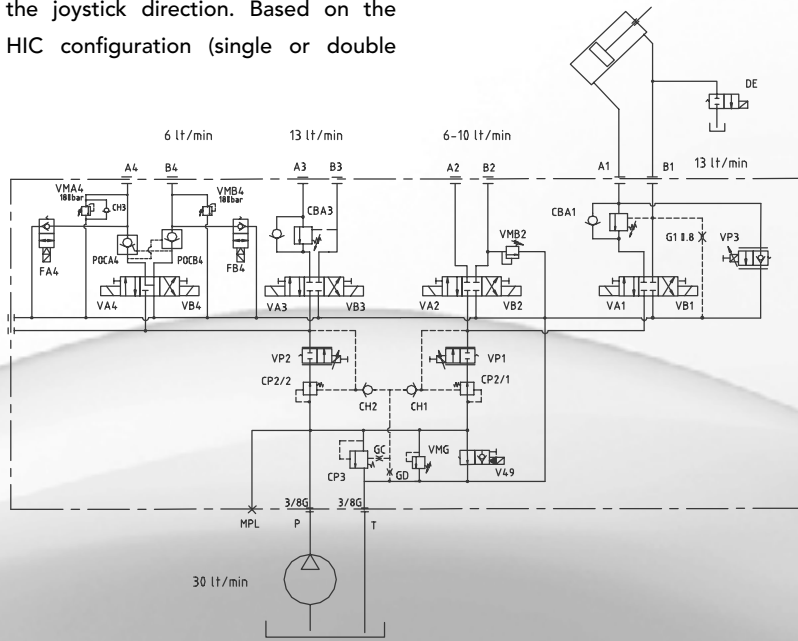

MAIN CONTROL VALVE

- FUNCTIONS**
- 1ST BOOM
 - 2ND BOOM
 - BOOM ROTATION
 - TELESCOPIC
 - HEAD INCLINATION
 - HEAD FLOAT

BOOM SUSPENSION VALVE

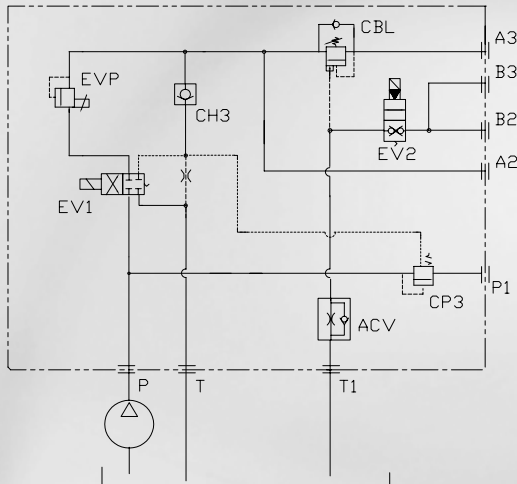

By the NC proportional relief EE-PRB (EVP) the pressure to the 1st boom cylinder compensates the boom weight, literally permitting the floating on the ground.

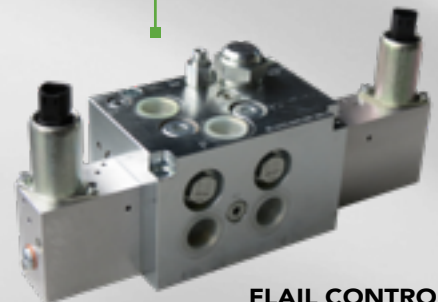
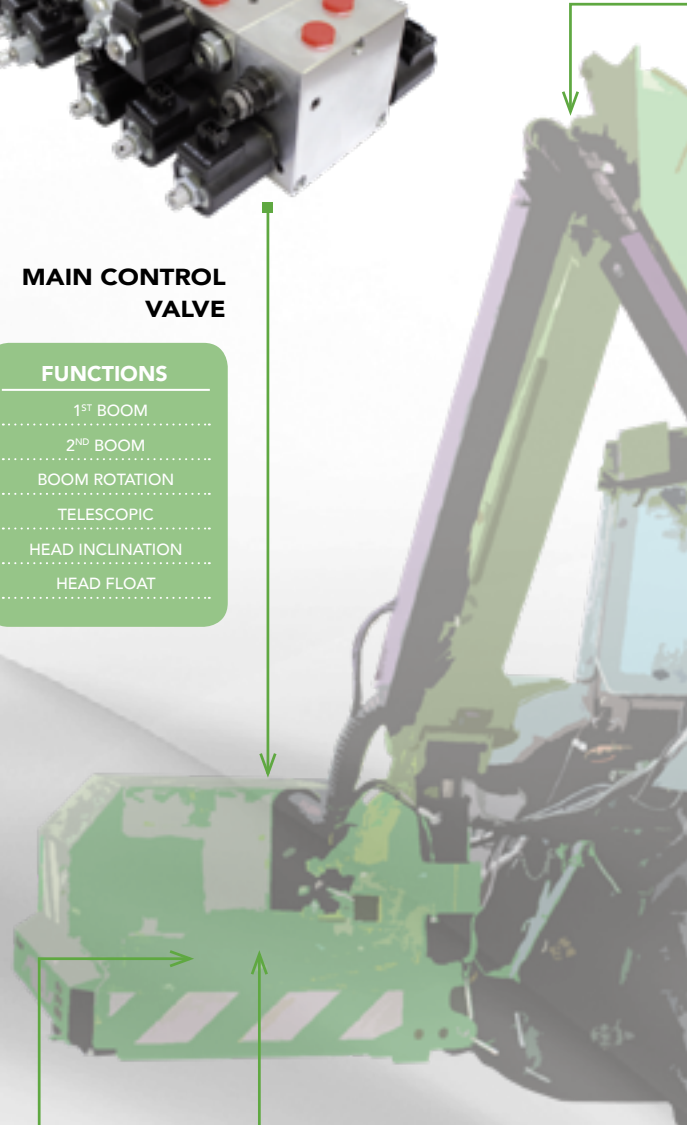
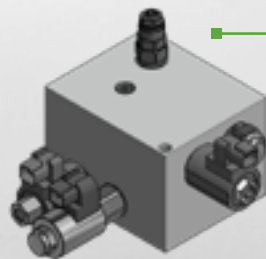

FLAIL CONTROL VALVE

(See page 4)

SINGLE AXIS INCLINOMETER

Feels the angular position of 1st boom permitting the automatic control of its positioning.



JOYSTICK JHM-L4D/CAN-MG

CAN proportionally control up to 5 functions, such as several digital functions. The movement configuration could be both cross (single Meter-in) or diagonal (double Meter-in). The generated CAN signal (J1939 or CANopen) is sent to the MMS ECU.



CANBUS



WIRING HARNESS

GRAPHIC DISPLAY EC-VIS-G

Connected to the CANbus, the mono-chromatic graphic display permits to the operator to control the machine functions (boom suspension pressure, float activation) and view their status. The panel layout can be customized according to the machine configuration.

V BATT
GND
CANH
CANL

TO HYDRAULICS

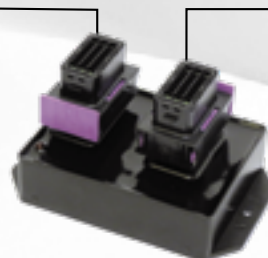

EC-MMS-2218-H

This Machine Management System gets CAN signals from the joystick, display and sensors and, according to a tailor-made software, generates both the PWM and on/off signals to control all the connected

hydraulic functions (boom control, boom suspension, flail control,...). The joystick axes configuration can be managed from the MMS, for instance creating virtual cross and prioritizing functions activation.

PROFESSIONAL RANGE MULTI-FUNCTIONAL PROPORTIONAL SYSTEM

MAIN CONTROL VALVE

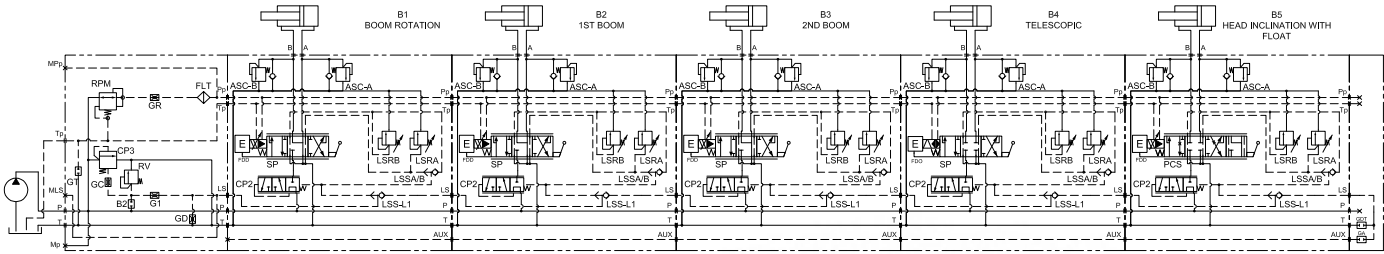

CLOSED LOOP TDV100LT - 00FDC

The proportional pilot head MLT-FD5 permits to reach the highest level of control accuracy of the spool valve: the true position of the spool is sensed by the integrated position sensor, permitting to the embedded electronics to get the exact valve flow, zeroing the hysteresis. The position feedback signal could be delivered to the MMS ECU to manage safety functions. The TDV100LT can be controlled by CANbus, easing the wiring and increasing the programming flexibility.

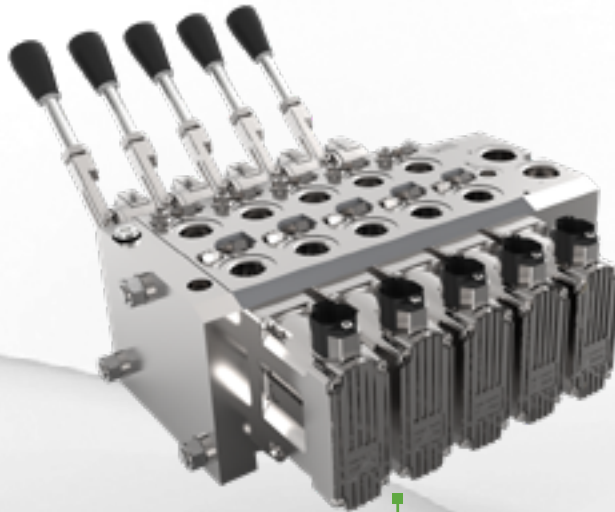

MAIN CONTROL VALVE

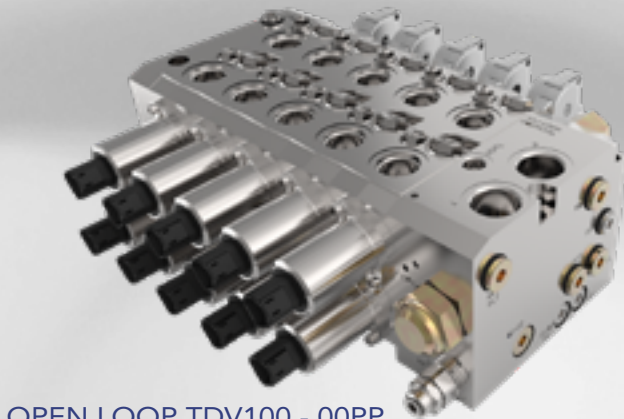

OPEN LOOP TDV100 - 00PP

BOOM SUSPENSION VALVE

(See page 6)

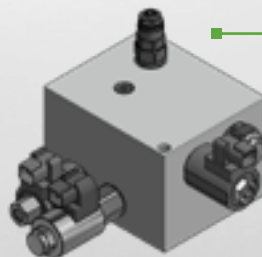

FLAIL CONTROL VALVE

(See page 4)

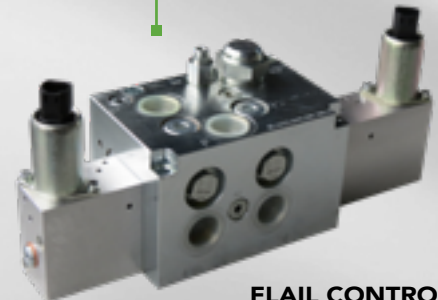

SINGLE AXIS INCLINOMETER

Feels the angular position of 1st boom permitting the automatic control of its positioning.



JOYSTICK JHM-L4D/CAN-MS

Can proportionally control up to 5 functions, such as several digital functions. The movement configuration could be both cross (single Meter-in) or diagonal (double Meter-in). The generated CAN signal (J1939 or CANopen) is sent to the MMS ECU.



CANBUS

GRAPHIC DISPLAY EC-VIS-GC

Connected to the CANbus, this colour graphic display permits to the operator to control the machine functions (boom suspension pressure, float activation) and view their status. The menus and sliding pages can be customized according to the machine configuration.



WIRING HARNESS



V BATT
GND
CANH
CANL

TO HYDRAULICS

EC-MMS-1521-H

With its double CAN connection and the possibility to generate up to 12 PWM signals, it permits to get the maximum control flexibility both with closed Loop and open loop spool valves. It gets CAN signals from the joystick, display, sensors, such as analog and digital signal from other machine devices and controls all the connected

hydraulic functions (boom control, boom suspension, flail control,...). The redundant micro-controller makes it compliant to safety regulation. The joystick axes configuration can be managed from the MMS, for instance creating virtual cross and prioritizing functions activation.

PRODUCT HIGHLIGHTS JOYSTICKS AND ARMRESTS

JHM HEAVY DUTY JOYSTICK

Designed for mobile application, it uses the contactless hall-effect technology to guarantee high control resolution, design robustness and long life (>5M Cycles).

Axes control configurations:

- ANH – 5V Analog Signals
- PWM – PWM Signals
- MLT – 5V Analog Signals
for Closed-Loop Systems
- CAN – J1939 or CANopen Signals



MS grip

- up to 3 Proportional Rollers
- up to 10 Push Buttons

MG grip

- up to 2 Proportional Rollers
- up to 9 Push Buttons

HR grip

- up to 2 Proportional Rollers
or 1 Mini-Joystick
- up to 6 Push Buttons



SPECIAL ARMREST

Designed on customer specifications.



ARMREST APPENDIX

For easy positioning of Joystick and Electronics into the cabin or joined to customer armrest.

FLEXIBLE ARMREST LAYOUT

Combining the configuration flexibility of both joystick grip and armrest panel, any machine layout can be easily covered. The special armrest design permits to contain both the EC-MMS-1012 and the EC-MMS-2218, for a compact plug&play solution.

EC-MMS-2218-H MACHINE MANAGEMENT SYSTEM

22 inputs and 18 outputs are managed by this small-size unit. Analog outputs are field-adjustable and their setting is stored in an EEPROM memory and can be loaded via software from vehicle's controller through CANbus or from a standard PC connected through an RS232 serial line.

SPECIFICATIONS

Analog inputs (10 bits).....	8 (0-5 V)
Digital inputs.....	14
High side power outputs.....	12 (3.5 A max)
PWM current feedback.....	1
Max. current load on all outputs.....	10 A
Analog outputs.....	6 (0-5 V)
CANbus protocol.....	J1939 or CANopen



EC-MMS-1521-H MACHINE MANAGEMENT SYSTEM CONTROLLER

It is normally used as the main control unit in a complete management system. Two microprocessors and advanced diagnostics for safety applications. The EC-MMS-1521-H comes with an aluminium casing, a silicon rubber gasket and connectors, designed to ensure power dissipation, robustness and tightness required in severe environment conditions (IP 69).

SPECIFICATIONS

Analog inputs (16 bits).....	3 (0-5V)
Analog inputs (10 bits).....	8 (0-5V)
Digital (frequency) inputs.....	4
High side power outputs.....	18 (6 if PWM outputs are used)
Low side power outputs (LS).....	2
PWM outputs with current feedback (3A).....	12
Analog voltage outputs (0-5V).....	1
Pins selectable as power OUT or digital IN.....	6
Inputs with SW selectable pull-up.....	4
CANbus lines.....	2 (ISO 11898, CAN 2.0A/B)



EC-VIS-G-D128X64-P GRAPHIC DISPLAY UNIT

Graphic display 128x64 dots backlighted with CANbus connection. Compact control unit to be fixed inside a cabin by robust suction cup on the rear.

SPECIFICATIONS

Communication interfaces.....	CANbus J1939
Analog inputs (10 bits).....	4 (0-5V)
Digital inputs.....	5
High side power outputs.....	4 (3.5A max. each)
Internal inputs for current feedback.....	4
PWM output current range.....	100 - 1500 mA
Membrane keypad with:	
Pushbuttons.....	11
SMD leds.....	11
Control potentiometer on the top.....	1



PRODUCT HIGHLIGHTS CARTRIDGE VALVES

PROPORTIONAL

IP-DAR-43C

Direct Acting Proportional, Pressure Reducing/Relieving, Slip-in Type

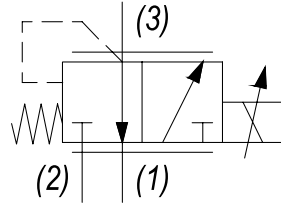
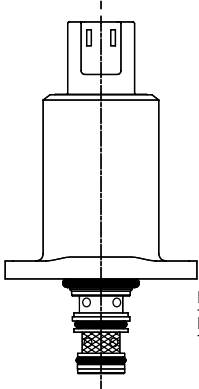

Nominal Flow	1 GPM (4 LPM) @ 8 bar Delta P
Max Inlet Pressure "H" version	5000 PSI (345 bar)

EE-PRB

2 Way Normally Closed, Proportional Relief Valve

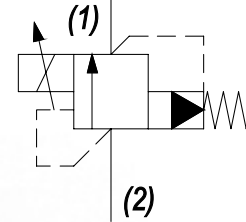
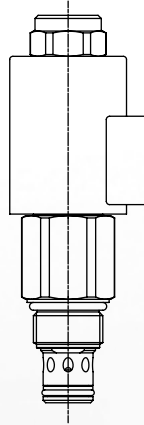

Nominal Flow	0+20 GPM (0+76 LPM)
Operating Range	100-3000 PSI (7-207 bar)

EE-P2H

2 Way Normally Open, Proportional Flow Control Valve

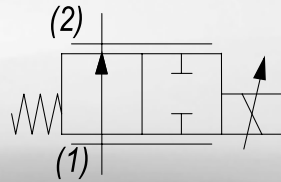
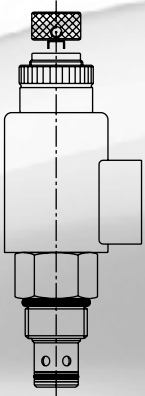

Flow Range	Up to 35 l/min
Max System Pressure	3500 PSI (241 bar)

EE-P2A

2 Way Normally Closed, Proportional Flow Control Valve

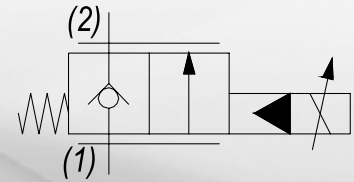
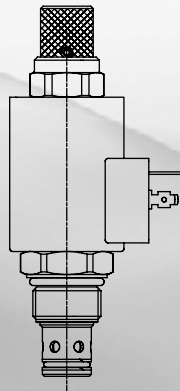

Flow Range	Up to 45 l/min
Max. System Pressure	3500 PSI (241 bar)

SOLENOID

HB-S2A

High Pressure Pilot Operated Poppet, 2 Way Normally Closed

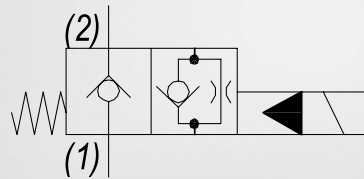
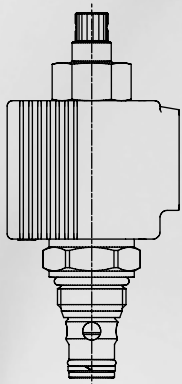

Nominal Flow	12 GPM (45 LPM)
Rated Operating Pressure	5000 PSI (345 bar)

DF-S3A

Direct Acting Spool, 3 Way 2 Position

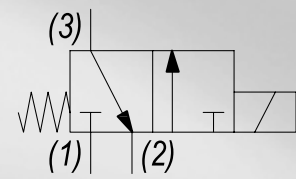
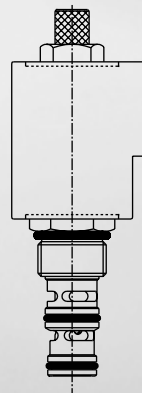

Nominal Flow	10 GPM (38 LPM)
Rated Operating Pressure	3000 PSI (207 bar)

TDV DIRECTIONAL PROPORTIONAL VALVE

STACKABLE DIRECTIONAL CONTROL VALVE SYSTEM

The **TDV100** is a closed center, load sensing, sectional control valve with pre-compensation. The **TDV100** can be configured with 1 to 10 working sections and can be used either with fixed displacement or with pressure/flow compensated variable displacement pumps.

Each **TDV100** sectional valve is crossed by a pilot pressure supply line and a return rail to feed around 20-25 bar to the MULTIDROM electro-hydraulic actuators system or proportional pilot pressure valves.



PRODUCT FEATURES AND BENEFITS

- Load-independent simultaneous control of two or more functions, within pump's flow saturation limits.
- Proportional flow control extended to 95% of spool stroke.
- MULTIDROM proportional actuators have built-in electronics requiring only variable voltage signals from a joystick.
- Internal closed loop position control configuration makes the valve spool achieving the desired position with accuracy levels approaching the performance of a servo-valve.
- Built-in CANbus interface working on SAE J1939 protocol.
- Non-feedback proportional and ON-OFF pilot pressure control actuators available.
- Electro-hydraulic, pressure compensated meter-in control of pump flow is available for cost-effective applications.
- Special "craning" spool configuration for overhung load control in conjunction with counterbalance valves.

SPECIFICATIONS

Max. operating flow	120 lt/min
Max. operating flow per section	110 lt/min
Max. working pressure	320 bar
Min. stand-by & pilot pressure	14 bar
Spool stroke	6 mm
Section width	42 mm
P & T Ports	3/4" - BSP
A & B work ports size	1/2" - BSP
Fluid	Mineral based oil
Fluid temperature range	-25°C/+95°C
Optimum fluid viscosity range	3<cSt<648
Max. fluid contamination level	18/15/10 (ISO 4406)
Seals	Buna-N (Std.) / Viton (Opt.)

TDV102 WORK SECTION CONTROL OPTIONS



TDV102-LMFD



TDV102-LMPP

COMPREHENSIVE PRODUCT LINE

Every year, more than 10 million components, sub-assemblies and systems are made at manufacturing premises in Modena, Italy and in Rockford Illinois, USA, classifiable in the following categories:

- Solenoid and mechanically operated cartridge valves
- Hydraulic Integrated Circuits - HIC
- Electrohydraulic proportional actuators
- Directional/proportional control valves
- Machine Management Systems - MMS
- Joysticks and controllers
- Pre-engineered systems
- Sensors
- Radio remote controls

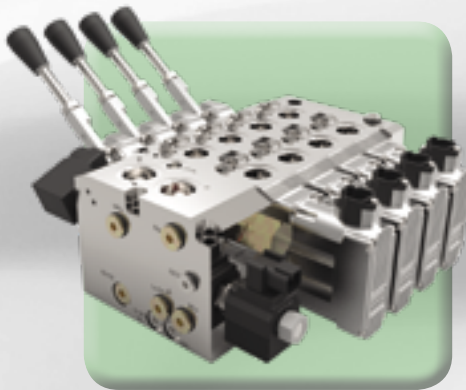

OUR MISSION

We develop and manufacture innovative components and systems, applying interrelated technologies and investing continuously in long-term business relationships. Since 1981, aware as to the potential benefits deriving from the integration of Hydraulics and Electronics, we have been encouraged to develop lines of innovative products that are now setting the industrial standard in various sectors

of use. TECNORD, in partnership since 1994 with DELTA POWER - USA and operating through a network that covers all the main markets worldwide, focuses primarily on manufacturing products that offer quality without compromise but are at the same time cost-effective, and on forging a long-term commitment to customer care, from initial contract through to after-sales service.



TECNORD

Via Malavolti, 36 - 41122 Modena - Italy - Tel. +39-059-254895 - Fax +39-059-253512
tecnord@tecnord.com - www.tecnord.com



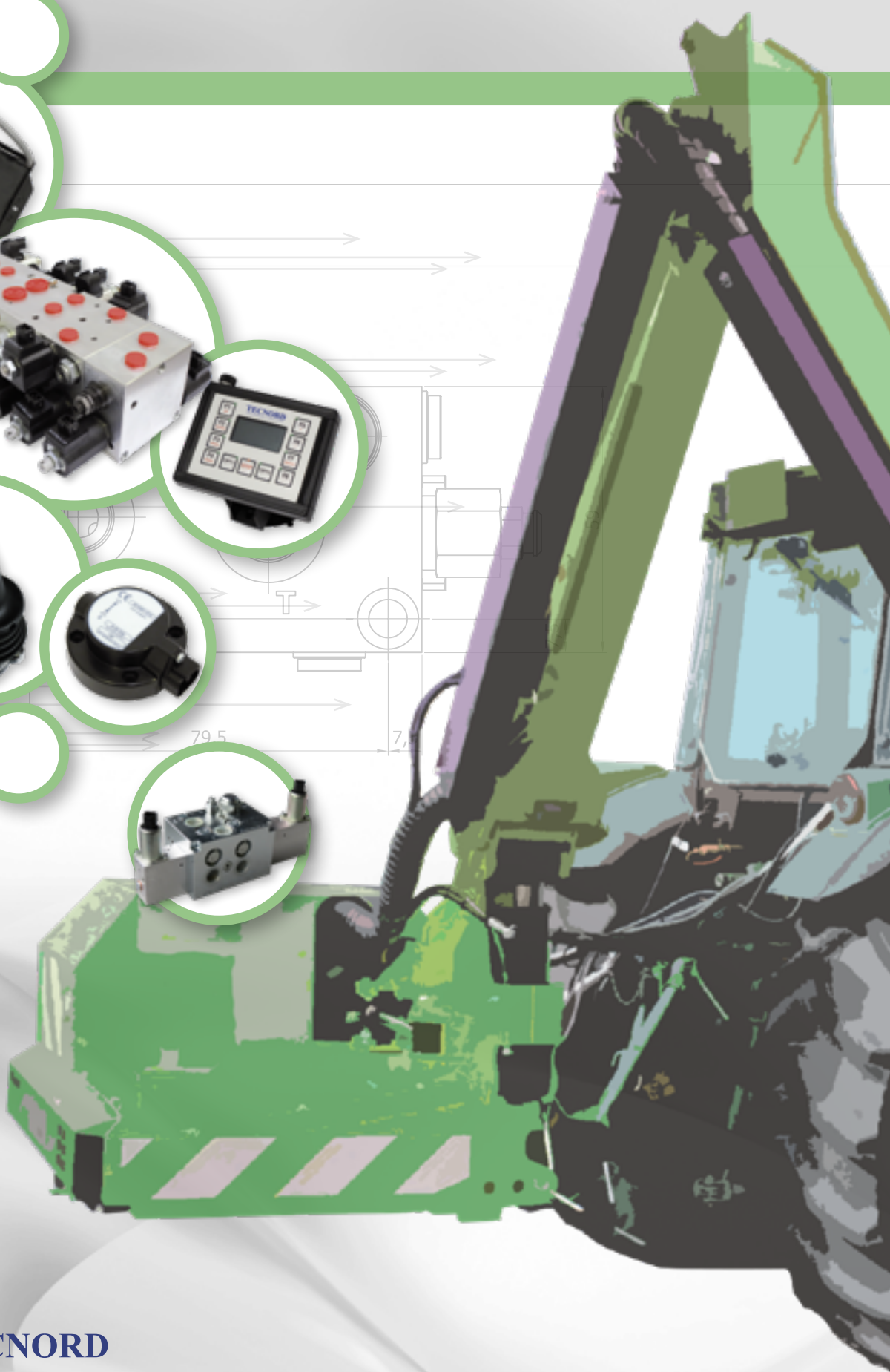
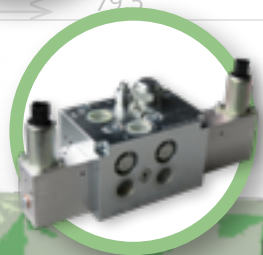
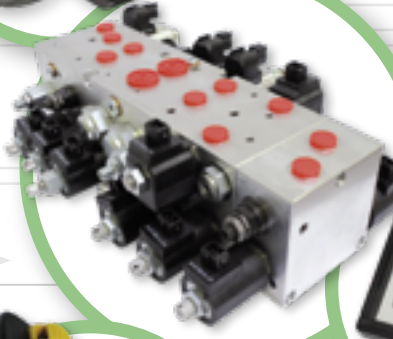

TECNORD

Via Malavolti, 36 - 41122 Modena - Italy - Tel. +39 (059) 254895 - Fax +39 (059) 253512
tecnord@tecnord.com - www.tecnord.com