

SK-FCP FIXED PRIORITY FLOW CONTROL VALVE

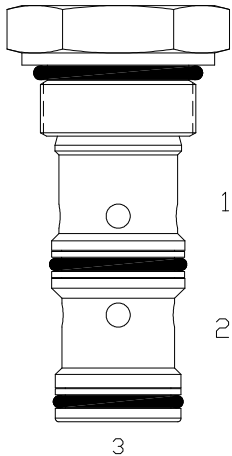

DESCRIPTION

16 size, 1 5/16-12 thread, "Super" series, fixed priority flow control valve.

OPERATION

The SK-FCP allows pressure compensated flow from (3) to (1) regulated by the pressure present at (3). Excess flow bypasses out (2). The spring chamber is constantly vented at (1).

FEATURES

- Hardened parts for long life.
- Industry common cavity.



For adjustable setting see SK-FCQ.

HYDRAULIC SYMBOL

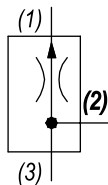

PERFORMANCE

Actual Test Data (Cartridge Only)

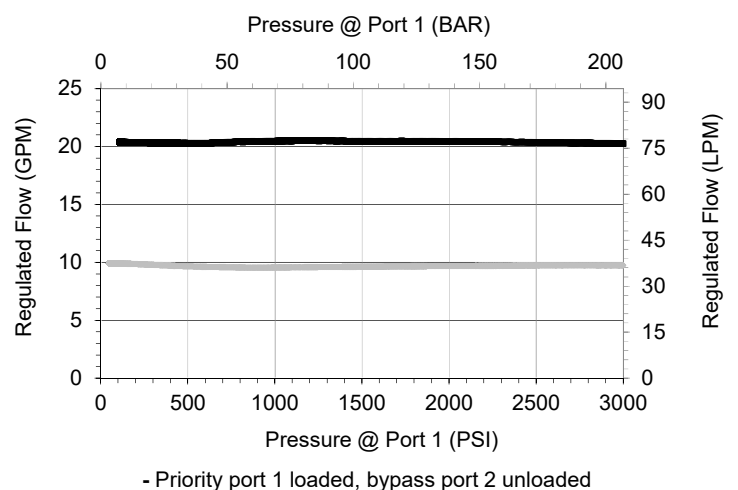
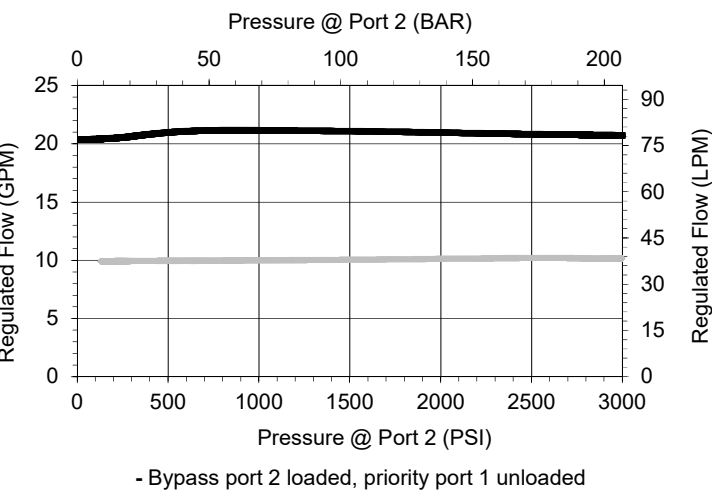

WARNING: the specifications/application data shown in our catalogs and data sheets are intended only as a general guide for the product described (herein). Any specific application should not be undertaken without independent study, evaluation, and testing for suitability.



4484 Boeing Drive Rockford, IL 61109 • USA • Phone +1 (815) 397-6628 • Fax +1 (815) 397-2526
 mail: delta@delta-power.com • www.delta-power.com



Via Malavolti, 36 • 41122 Modena • ITALY • Phone +39 (059) 254895 • Fax +39 (059) 253512
 mail: tecnord@tecnord.com • www.tecnord.com

DIMENSIONS

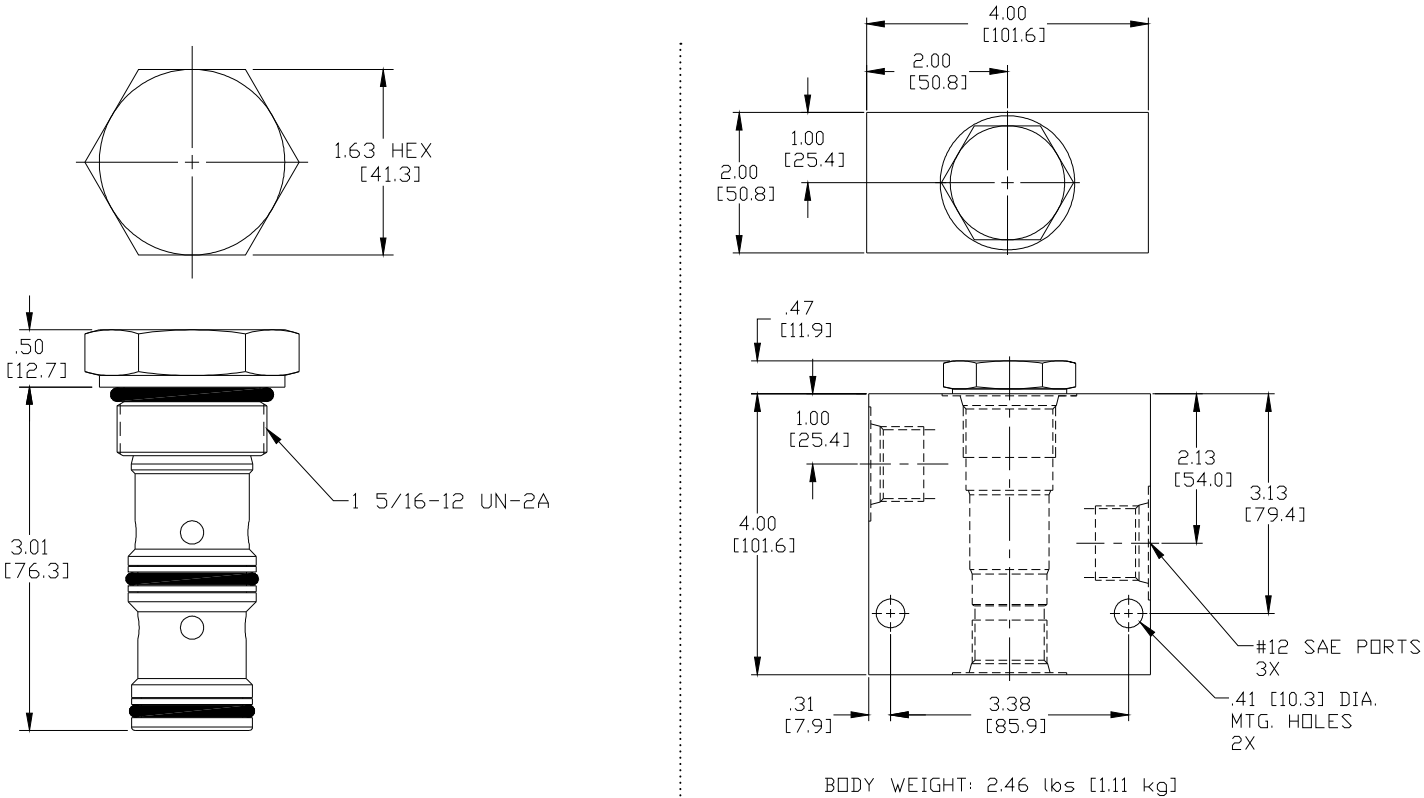

Body Weight: 2.46 lbs (1.11 kg)

ORDERING INFORMATION

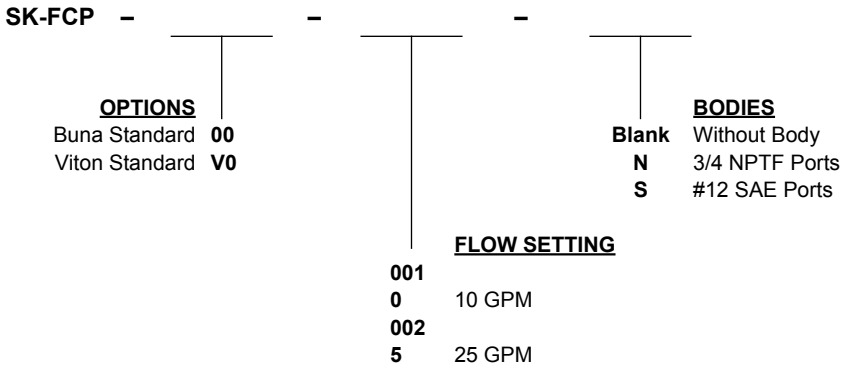

Additional flow settings available upon request

W6 / 2020

WARNING: the specifications/application data shown in our catalogs and data sheets are intended only as a general guide for the product described (herein). Any specific application should not be undertaken without independent study, evaluation, and testing for suitability.



4484 Boeing Drive Rockford, IL 61109 • USA • Phone +1 (815) 397-6628 • Fax +1 (815) 397-2526
 mail: delta@delta-power.com • www.delta-power.com



Via Malavolti, 36 • 41122 Modena • ITALY • Phone +39 (059) 254895 • Fax +39 (059) 253512
 mail: tecnord@tecnord.com • www.tecnord.com