

DE-S2A PILOT OPERATED POPPET, 2 WAY NORMALLY CLOSED

DESCRIPTION

10 size, 7/8-14 thread, "Delta" series, solenoid operated, 2 way normally closed, pilot operated poppet valve with reverse flow de-energized.

OPERATION

When de-energized the DE-S2A blocks flow from (1) to (2) and allows reverse flow from (2) to (1). When energized the valve allows flow from (1) to (2) and restricts flow from (2) to (1).

OPERATION OF MANUAL OVERRIDE OPTION: to override, turn the manual override screw counterclockwise. To release turn the manual override screw clockwise.

FEATURES

- Hardened parts for long life.
- Efficient wet-armature construction.
- Cartridges are voltage interchangeable.
- Manual override option.
- Industry common cavity.
- Unitized, molded coil design.
- Continuous duty rated solenoid.
- Optional coil voltages and terminations.
- Optional "I" Coil: Weatherproof, Thermal Shock, Immersion Safe.

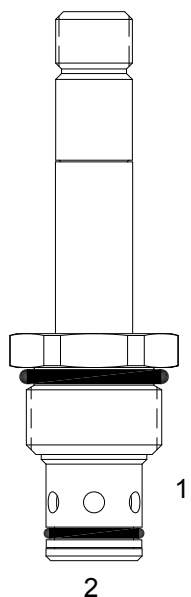

HYDRAULIC SYMBOL

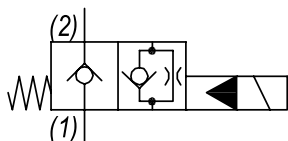

PERFORMANCE

Actual Test Data (Cartridge Only)

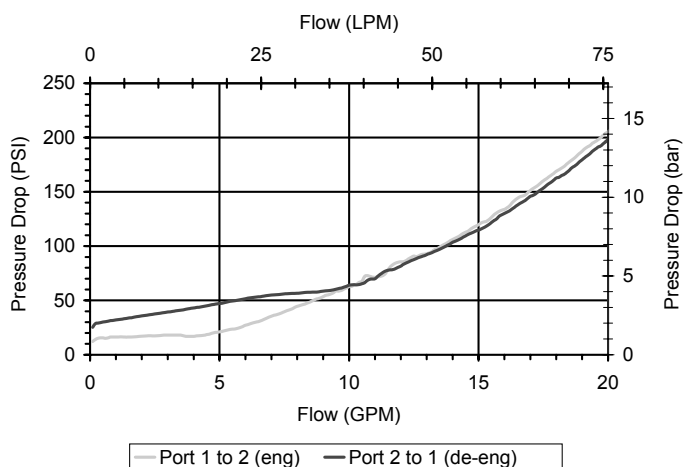

VALVE SPECIFICATIONS

Nominal Flow	15 GPM (57 LPM)
Rated Operating Pressure	3500 PSI (241 bar)
Typical Internal Leakage (150 SSU)	0-5 drops/min
Viscosity Range	36 to 3000 SSU (3 to 647 cSt)
Filtration	ISO 18/16/13
Media Operating Temp. Range	-40° to 250°F (-40° to 120°C)
Weight	.27 lbs (.12 kg)
Operating Fluid Media	General Purpose Hydraulic Fluid
Cartridge Torque Requirements	30 ft-lbs (40.6 Nm)
Coil Nut Torque Requirements	4-6 ft-lbs (5.4-8.1 Nm)
Cavity	DELTA 2W
Cavity Tools Kit	
(form tool, reamer, tap)	40500000
Seal Kit	21191200

WARNING: the specifications/application data shown in our catalogs and data sheets are intended only as a general guide for the product described (herein). Any specific application should not be undertaken without independent study, evaluation, and testing for suitability.



4484 Boeing Drive Rockford, IL 61109 • USA • Phone +1 (815) 397-6628 • Fax +1 (815) 397-2526
 mail: delta@delta-power.com • www.delta-power.com



Via Malavolti, 36 • 41122 Modena • ITALY • Phone +39 (059) 254895 • Fax +39 (059) 253512
 mail: tecnord@tecnord.com • www.tecnord.com

DIMENSIONS

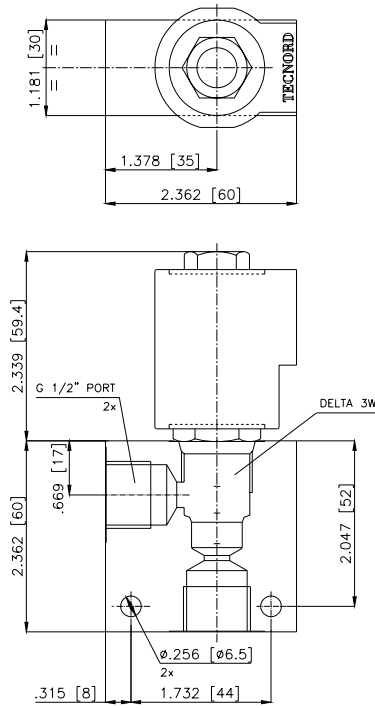
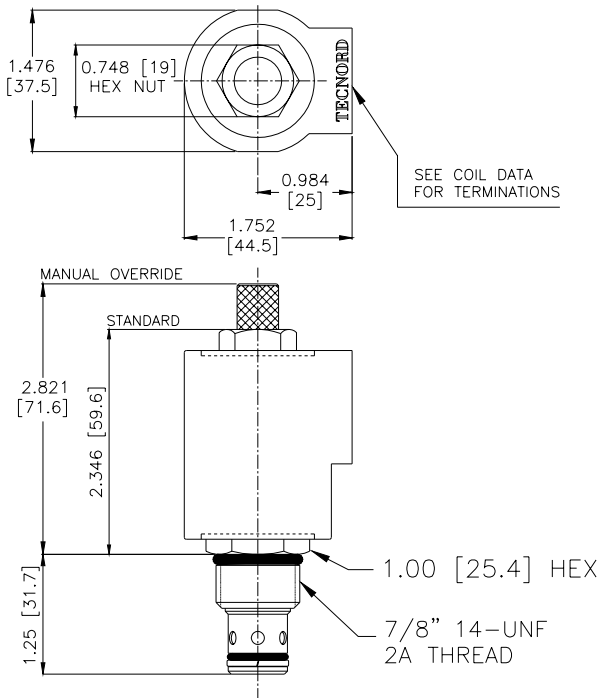

ORDERING INFORMATION

Approximate Coil Weight: .56 lbs (.25 kg)

DE-S2A - - - -

- OPTIONS**
- Buna Standard **00**
 - Viton Standard **V0**
 - Buna, Override, Detent **0M**
 - Viton, Override, Detent **VM**
 - Buna, Screen **A0**
 - Viton, Screen **W0**
 - Buna, Screen, Override **B2**
 - Viton, Screen, Override **V2**

Note: use screen only if flow direction is from (1) to (2)

"V" COIL TERMINATION
(All DC Except as Noted)

DL Double Lead
(several types of termination can be attached on leads on request)

HC DIN 43650 (Hirschmann) - (AC&DC)
DI Deutsch - Integral DT04-2P

IMMERSION PROOF "D" TYPE

- DIA** "I" Coil AMP Superseal - Integral
- DID** "I" Coil Deutsch - Integral DT04-2P
- DIJ** "I" Coil AMP Jr. Timer - Integral
- DIM** "I" Coil Metri-Pack - Integral

- BODIES**
- Blank** Without Body
 - N** 1/2" BSP Ports
 - S** #8 SAE Ports

- VOLTAGE** (other voltages available on request)
- 12** 12 VDC
 - 24** 24 VDC
 - 22** 220 VAC without internal rectifier

W 9 / 2020

WARNING: the specifications/application data shown in our catalogs and data sheets are intended only as a general guide for the product described (herein). Any specific application should not be undertaken without independent study, evaluation, and testing for suitability.



4484 Boeing Drive Rockford, IL 61109 • USA • Phone +1 (815) 397-6628 • Fax +1 (815) 397-2526
mail: delta@delta-power.com • www.delta-power.com



Via Malavolti, 36 • 41122 Modena • ITALY • Phone +39 (059) 254895 • Fax +39 (059) 253512
mail: tecnord@tecnord.com • www.tecnord.com