

PB-RVA DIRECT ACTING RELIEF VALVE

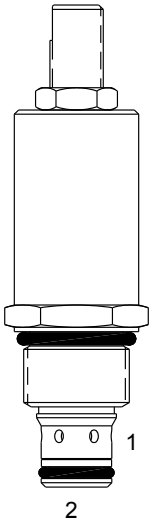

DESCRIPTION

8 size, 3/4-16 thread, "Power" series, direct acting relief valve.

OPERATION

The PB-RVA blocks flow from (2) to (1) until sufficient pressure is present at (2) to force the poppet to open and allow metered flow from (2) to (1). The cartridge offers smooth transition in response to load changes in common hydraulic circuits.

FEATURES

- Hardened parts for long life.
- Industry common cavity.

HYDRAULIC SYMBOL

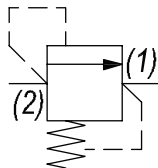

Pressure at port (1) must not exceed 2500 PSI.

PERFORMANCE

Actual Test Data (Cartridge Only)

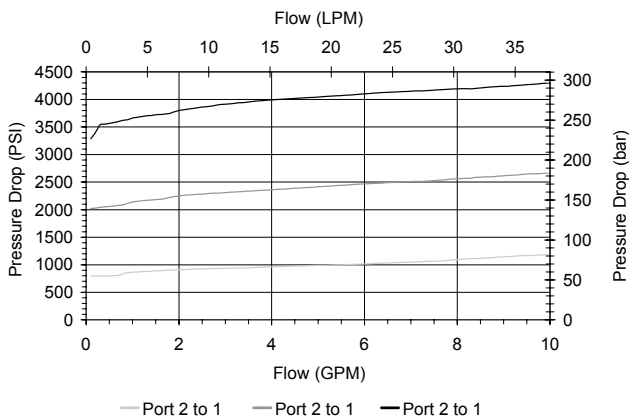

VALVE SPECIFICATIONS

Nominal Flow	6 GPM (23 LPM)
Rated Operating Pressure	3500 PSI (241 bar)
Viscosity Range	36 to 3000 SSU (3 to 647 cSt)
Filtration	ISO 18/16/13
Media Operating Temp. Range	-40° to 250°F (-40° to 120°C)
Weight	.30 lbs (.14 kg)
Operating Fluid Media	General Purpose Hydraulic Fluid
Cartridge Torque Requirements	25 ft-lbs (34 Nm)
Cavity	POWER 2W
Cavity Form Tool (Finishing)	40500005
Seal Kit	21191100

WARNING: the specifications/application data shown in our catalogs and data sheets are intended only as a general guide for the product described (herein). Any specific application should not be undertaken without independent study, evaluation, and testing for suitability.



4484 Boeing Drive Rockford, IL 61109 • USA • Phone +1 (815) 397-6628 • Fax +1 (815) 397-2526
 mail: delta@delta-power.com • www.delta-power.com



Via Malavolti, 36 • 41122 Modena • ITALY • Phone +39 (059) 254895 • Fax +39 (059) 253512
 mail: tecnord@tecnord.com • www.tecnord.com

DIMENSIONS

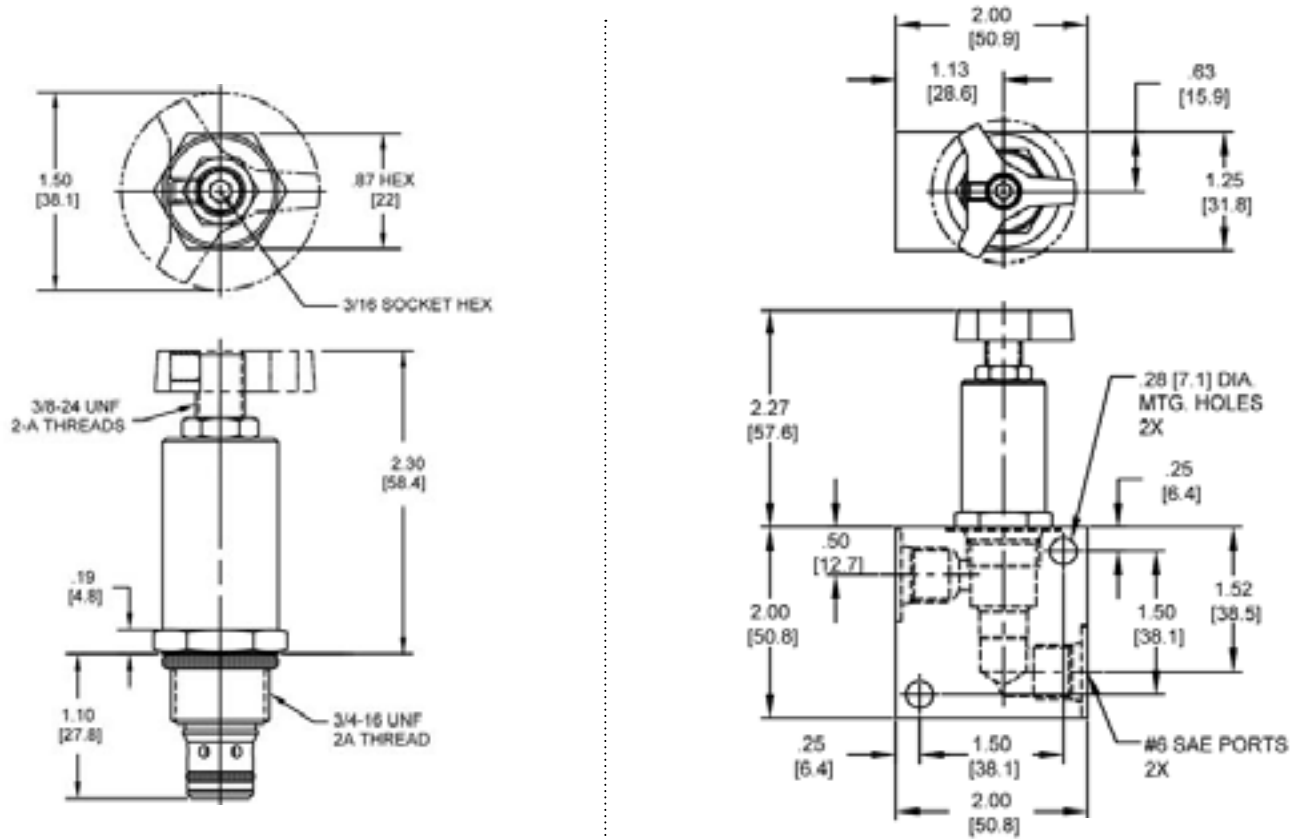

Body Weight: .39 lbs (.18 kg)

ORDERING INFORMATION

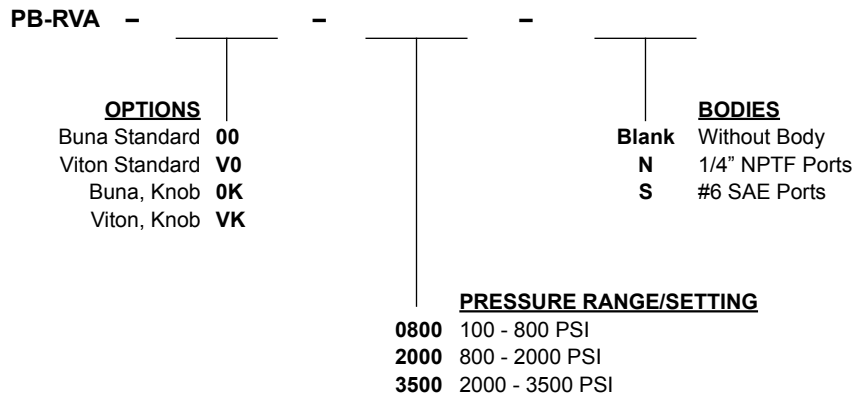

W 12 / 2020

WARNING: the specifications/application data shown in our catalogs and data sheets are intended only as a general guide for the product described (herein). Any specific application should not be undertaken without independent study, evaluation, and testing for suitability.



4484 Boeing Drive Rockford, IL 61109 • USA • Phone +1 (815) 397-6628 • Fax +1 (815) 397-2526
 mail: delta@delta-power.com • www.delta-power.com



Via Malavolti, 36 • 41122 Modena • ITALY • Phone +39 (059) 254895 • Fax +39 (059) 253512
 mail: tecnord@tecnord.com • www.tecnord.com