

**DE-RCD DIFFERENTIAL AREA RELIEF VALVE**

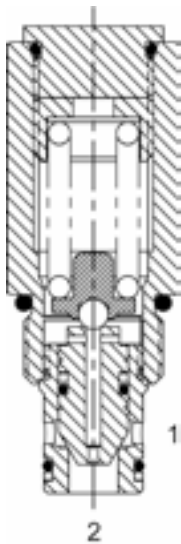

**DESCRIPTION**

10 size, 7/8-14 thread, "Delta" series, differential area relief valve.

**OPERATION**

The DE-RCD blocks flow from (1) to (2) until sufficient pressure is present at (1) to force the poppet to open and allow metered flow from (1) to (2). The cartridge offers smooth transition in response to load changes in common hydraulic circuits.

**FEATURES**

- Hardened parts for long life.
- Industry common cavity.

**HYDRAULIC SYMBOL**

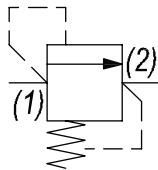

*Installation Space Saving Product. Cannot be field adjusted. Not recommended for crossover relief valve applications, use DE-RWD.*

**PERFORMANCE**

Actual Test Data (Cartridge Only)

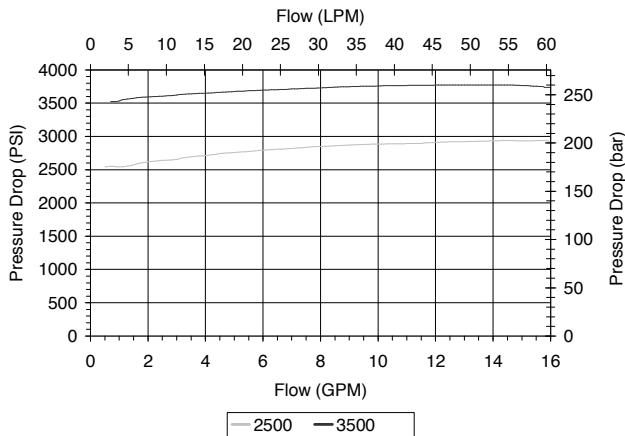

**VALVE SPECIFICATIONS**

Nominal Flow	15 GPM (57 LPM)
Rated Operating Pressure	3500 PSI (241 bar)
Viscosity Range	36 to 3000 SSU (3 to 647 cSt)
Filtration	ISO 18/16/13
Media Operating Temp. Range	-40° to 250°F (-40° to 120°C)
Weight	.37 lbs (.17 kg)
Operating Fluid Media	General Purpose Hydraulic Fluid
Cartridge Torque Requirements	30 ft-lbs (40.6 Nm)
Cavity	DELTA 2W
Cavity Form Tool (Finishing)	40500000
Seal Kit	21191200

**WARNING:** the specifications/application data shown in our catalogs and data sheets are intended only as a general guide for the product described (herein). Any specific application should not be undertaken without independent study, evaluation, and testing for suitability.



4484 Boeing Drive Rockford, IL 61109 • USA • Phone +1 (815) 397-6628 • Fax +1 (815) 397-2526  
 mail: delta@delta-power.com • www.delta-power.com



Via Malavolti, 36 • 41122 Modena • ITALY • Phone +39 (059) 254895 • Fax +39 (059) 253512  
 mail: tecnord@tecnord.com • www.tecnord.com

**DIMENSIONS**

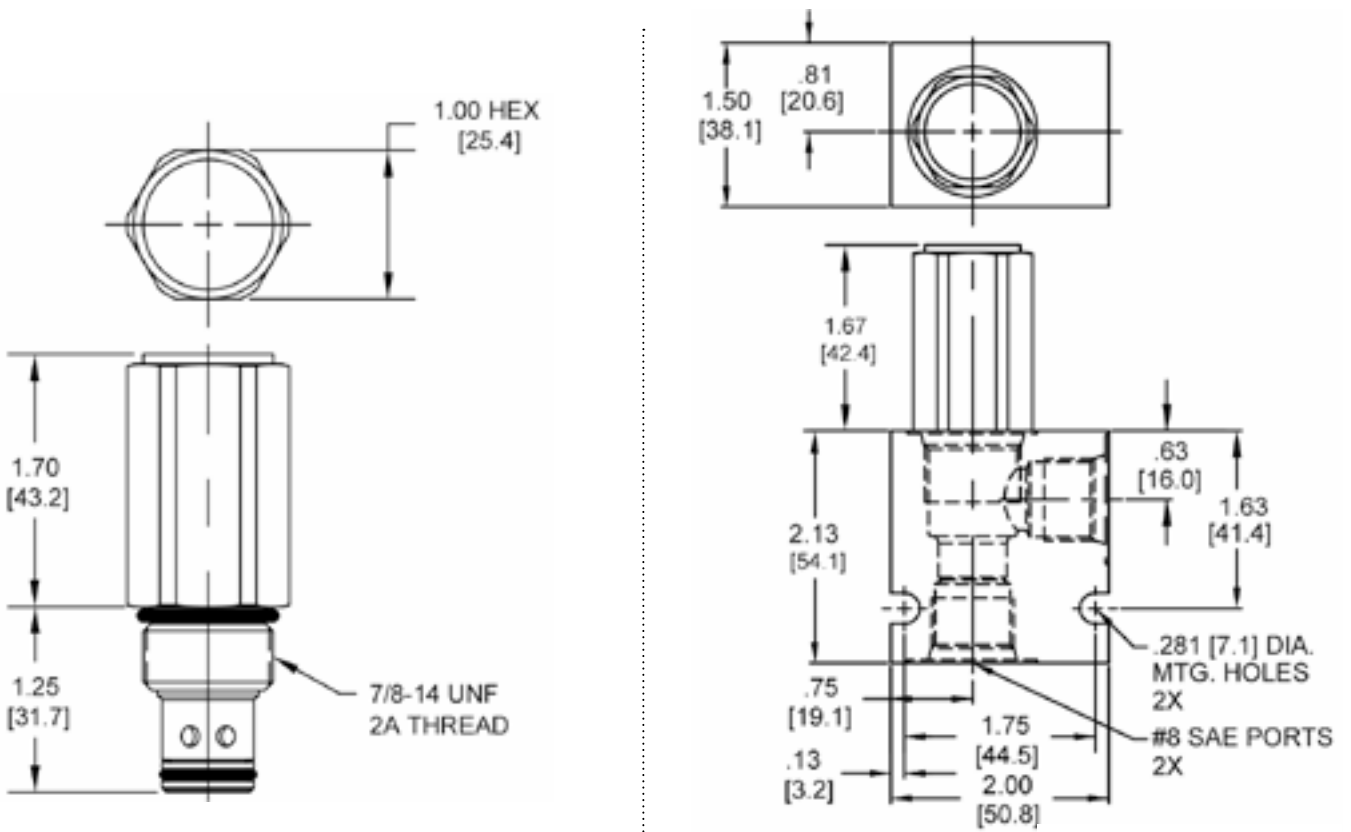

Body Weight: .47 lbs (.21 kg)

**ORDERING INFORMATION**

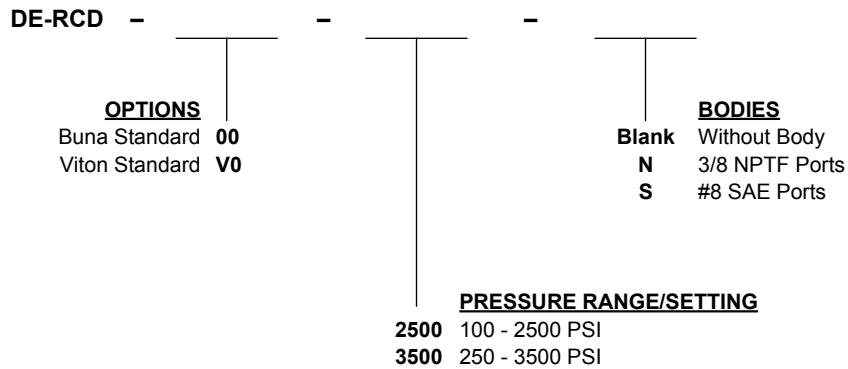

W 12 / 2020

**WARNING:** the specifications/application data shown in our catalogs and data sheets are intended only as a general guide for the product described (herein). Any specific application should not be undertaken without independent study, evaluation, and testing for suitability.



4484 Boeing Drive Rockford, IL 61109 • USA • Phone +1 (815) 397-6628 • Fax +1 (815) 397-2526  
 mail: delta@delta-power.com • www.delta-power.com



Via Malavolti, 36 • 41122 Modena • ITALY • Phone +39 (059) 254895 • Fax +39 (059) 253512  
 mail: tecnord@tecnord.com • www.tecnord.com