

MA-CVS DIRECT ACTING CHECK VALVE, SOFT SEAT, POPPET

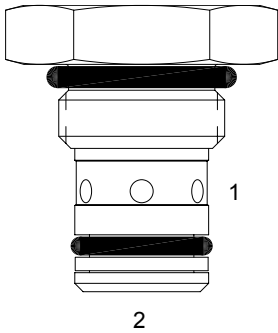

DESCRIPTION

7 size, 5/8-18 Thread, "Mini" series, direct acting check valve, soft seat, poppet.

OPERATION

The MA-CVS allows free flow (2) to (1) and blocks flow from (1) to (2). The cartridge has a fully guided poppet, which is spring-biased closed, until sufficient pressure is applied at (2) to open (1).

FEATURES

- Soft seat for ultra low leakage.
- Industry common cavity.
- Optional bias springs for backpressure application flexibility.
- Fully guided poppet.

HYDRAULIC SYMBOL

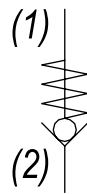

PERFORMANCE

Actual Test Data (Cartridge Only)

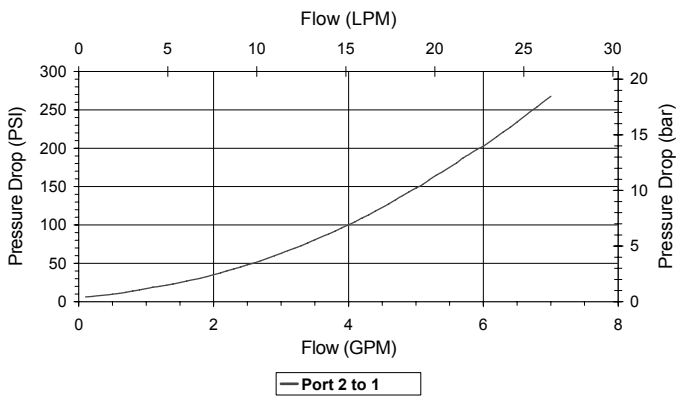

VALVE SPECIFICATIONS

Nominal Flow	2.5 GPM (9.5 LPM)
Rated Operating Pressure	1500 PSI (103 bar)
Typical Internal Leakage (150 SSU)	Negligible
Viscosity Range	36 to 3000 SSU (3 to 647 cSt)
Filtration	ISO 18/16/13
Media Operating Temp. Range	-32° to 160°F (0° to 70°C)
Weight	.08 lbs (.03 kg)
Operating Fluid Media	General Purpose Hydraulic Fluid
Cartridge Torque Requirements	15 ft-lbs (20.3 Nm)
Cavity	MINI 2W
Cavity Form Tool (Finishing)	40500003
Seal Kit	21191000

WARNING: the specifications/application data shown in our catalogs and data sheets are intended only as a general guide for the product described (herein). Any specific application should not be undertaken without independent study, evaluation, and testing for suitability.



4484 Boeing Drive Rockford, IL 61109 • USA • Phone +1 (815) 397-6628 • Fax +1 (815) 397-2526
 mail: delta@delta-power.com • www.delta-power.com



Via Malavolti, 36 • 41122 Modena • ITALY • Phone +39 (059) 254895 • Fax +39 (059) 253512
 mail: tecnord@tecnord.com • www.tecnord.com

DIMENSIONS

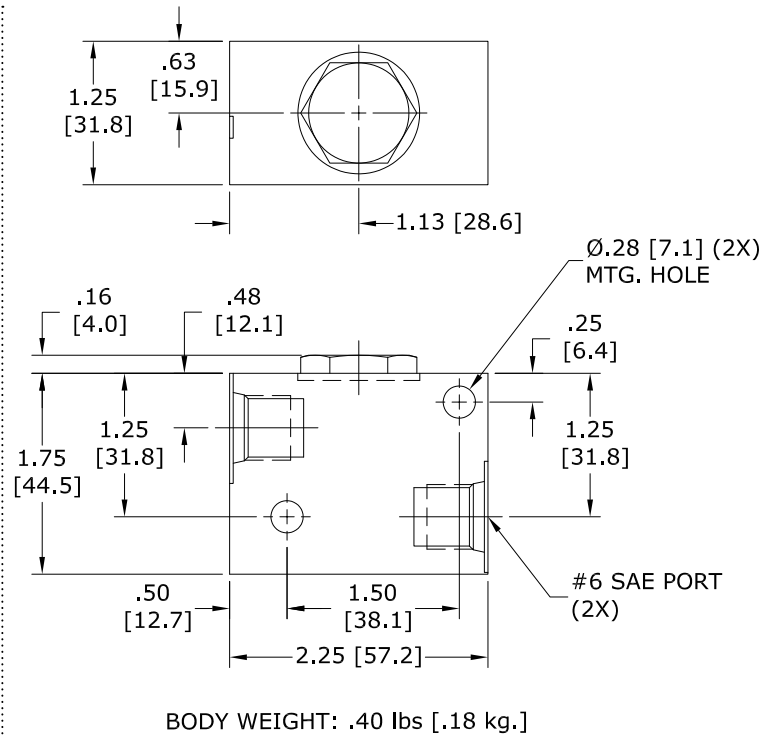
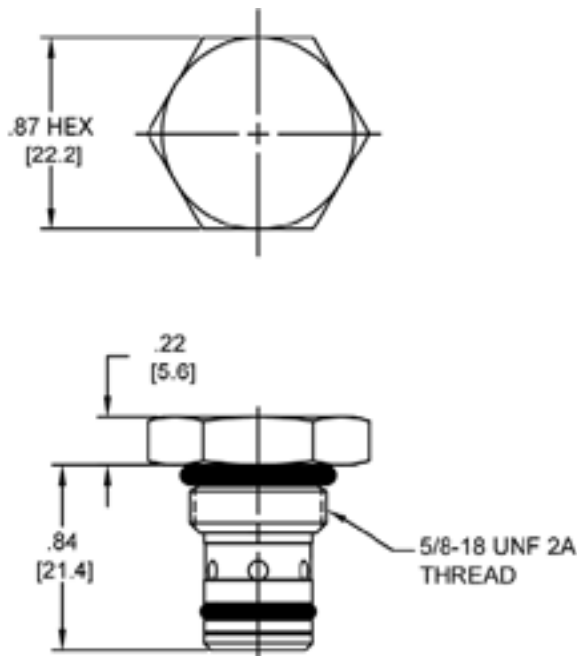

Body Weight: .29 lbs (.13 kg)

ORDERING INFORMATION

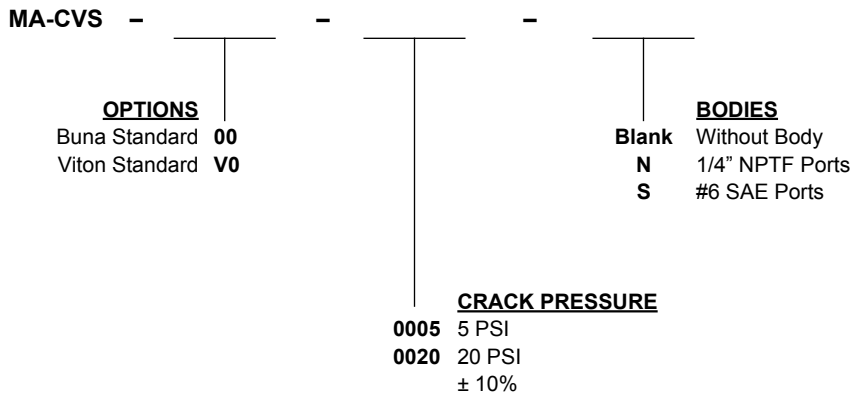

W14 / 2018

WARNING: the specifications/application data shown in our catalogs and data sheets are intended only as a general guide for the product described (herein). Any specific application should not be undertaken without independent study, evaluation, and testing for suitability.



4484 Boeing Drive Rockford, IL 61109 • USA • Phone +1 (815) 397-6628 • Fax +1 (815) 397-2526
 mail: delta@delta-power.com • www.delta-power.com



Via Malavolti, 36 • 41122 Modena • ITALY • Phone +39 (059) 254895 • Fax +39 (059) 253512
 mail: tecnord@tecnord.com • www.tecnord.com